

31AE6LLG790 SB-628 (2005-2)
Chute Assembly

Page 2 of 9

Ref #	Part Number	Qty	S/P/F	Description
1	731-2635	1		Snow Removal Tool Mount
2	684-04057	1	S	Impeller Assembly, 12" Dia.
3	710-0347	1	/P	Hex Screw, 3/8-16, 1.75, Gr5
4	710-0451	1	/P	Bolt, Carriage, 5/16-18, .750
5	710-0604A	1	/P	Screw, 5/16-18, 0.625
6	710-0703	1	/P	Screw, Carriage, 1/4-20, .750, Gr 5
7	712-04063	1	/P	Nut, Flange Lock, 5/16-18, Nylon
8	712-04064	1	/P	Nut, Flange Lock, 1/4-20, Nylon
9	712-04065	1	/P	Nut, Flange Lock, 3/8-16, Nylon
10	714-04040	1		Cotter Pin, Bow-tie
11	725-0157	1	/P	Cable, Tie, 3/16 x .05 x7.4
12	726-04012	1	S	Nut, Push-on, .25 Dia
13	731-04705	1	S	Chute, Adapter 5" Dia
14	732-0611	1	S	Spring, Extension, .38 OD x 3.6
15	736-0174	1	/P	Washer, Wave, .625 x .885
16	736-0242	1	/P	Washer, Bell, .340 x .872
17	736-0463	1	S	Washer, Flat, .25 x .630 x .0515
18	731-2643	1	S	Snow Removal Tool
19	738-0143	1	/P	Screw, Shoulder, .498 x .34, 3/8-16
20	738-0281	1	S	Screw, Shoulder, .625 x .17, 3/8-16
21	738-04124A	1	/P	Shear Pin, .25 x 1.50
22	741-0245	1	S	Bearing, Hex Flange x .75
23	741-0309	1	S	Bearing, Ball, .75 ID x 1.85 OD
24	756-0981A	1	S	Flat Pulley, Idler, 2.75 OD
25	790-00075	1		Housing, Bearing, 1.85 ID
26	790-00080	1		Bracket, Auger Idler w/Brake
27	618-04172	1	S	Gearbox Assembly, Auger, 26"
27	618-04173	1	S	Gearbox Assembly, Auger, 28"
28	684-04071	1		Housing Assembly, Auger 26"
28	684-04073	1		Housing Assembly, Auger 28"
29	684-04107	1		Spiral Assembly, LH
30	684-04108	1		Spiral Assembly, RH
31	731-04870	1	F	Spacer, 1.25 OD x .75 ID x1.00 - See footnote
32	736-0188	1	/P	Washer, Flat, .76 x 1.49 x .06
33	741-0493A	1	/P	Bushing, Flange, .80 ID x .91 OD
34	790-00087A	1		Housing, 1" Hex Bearing
35	790-00121	1		Shave Plate, 2.25 x 25.66
35	790-00118	1		Shave Plate, 2.25 x 27.66
36	784-5580	1		Slide Shoe
37	719-0319	1	S	Housing, Auger, RH Reduced
38	719-0320	1	S	Housing, Auger, LH Reduced
39	721-0179	1	S	Seal, Oil, .750 ID
40	741-0662	1		Bearing, Flange, .75 x 1.0
41	710-0642	1	/P	Screw, Self-tapping, 1/4-20, 0
42	711-04284	1		Axle, Auger, 26"
42	711-04283	1		Axle, Auger, 28"
43	714-0161	1	S	Key, Hi-pro 3/16 x 5/8
44	715-04021	1		Pin, Dowel, .25 OD x 1.2
45	717-04126	1	S	Shaft, Worm .75 OD
46	717-0528A	1	S	Gear, Worm 20T
47	718-04071	1		Collar, Thrust
48	721-0325	1		Plug, 1/4 x .437
49	721-0327	1		Plug, 1/4 x .131

31AE6LLG790 SB-628 (2005-2)
Chute Assembly

Page 3 of 9

Ref #	Part Number	Qty	S/P/F	Description
50	736-0351	1	S	Washer, Flat, .760 ID x 1.5 OD
51	736-3084	1	/P	Washer, Flat, .51 x 1.12
52	741-0663	1		Bearing, Flange, .75 x 1.0 x .925
53	741-0661A	1	/P	Bearing, Flange, .75 x 1.00 x .975
54	746-04230	1		Clutch Cable, Auger, 47.23"
55	629-0071	1	S	Extension Cord, 110V

31AE6LLG790 SB-628 (2005-2)
Drive Assembly

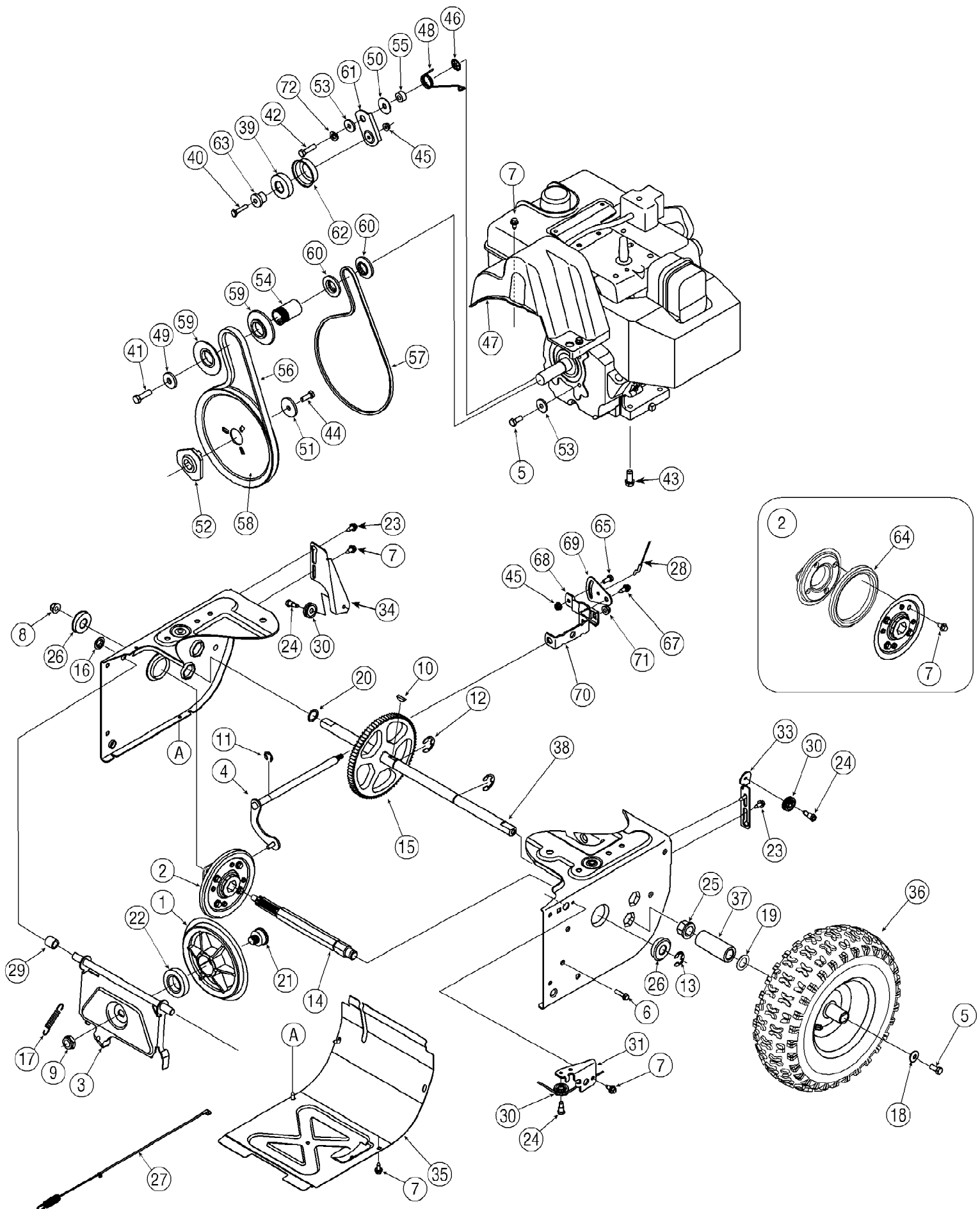

31AE6LLG790 SB-628 (2005-2)
Drive Assembly

Page 5 of 9

Ref #	Part Number	Qty	S/P/F	Description
1	756-04177	1	S	Disc, Friction Wheel
2	684-04153	1		Friction Wheel Assembly, 5.5 OD
3	684-04154	1	S	Support Bracket, Friction Wheel
4	684-04156	1		Shift Assembly, Rod
5	710-0627	1	/P	Hex Screw, 5/16-24, .750, Gr5
6	710-0788	1	/P	Screw, 1/4-20, 1.000
7	710-0896	1	/P	Screw, 1/4-14 x .625
8	712-04065	1	/P	Nut, Flange Lock, 3/8-16, Nylon
9	712-0413	1	S	Nut, Jam Lock, 5/8-18, Gr5, Nylon
10	714-0126	1	S	Key, Hi Pro, 3/16 x 3/4 Dia
11	716-0104	1	S	E-ring, .500 Dia.
12	716-0136	1		E-ring, Retaining, .875 Dia.
13	716-0231	1	S	E-ring, .750 Dia.
14	717-04209	1	S	Hex Shaft, .8125, 7-Tooth
15	717-04230	1	S	Gear, 80-Tooth
16	726-0221	1	/P	Speed Nut, .500
17	732-0264	1	S	Extension Spring
18	736-0242	1	/P	Washer, Bell, .340 x .872 x .060
19	736-0287	1	S	Washer, Flat, .793 x 1.24 x .060
20	736-04161	1		Washer, Flat, .75 x 1.00 x .060
21	738-04164	1		Pin, Friction Disc
22	741-04098	1		Ball Bearing, 30 x 55 x .13
23	738-04184	1		Screw, Shoulder, .37 x .105, 1/4-20
24	738-0924	1	S	Screw, 1/4-28, .375
25	741-0245	1	S	Bearing, Hex Flange x .75 ID
26	741-0563	1	S	Bearing, Ball, 17 x 40 x 12
27	746-04229	1		Clutch Cable, Wheel, 44.95"
28	746-04230	1		Clutch Cable, Auger, 47.23"
29	748-0190	1	/P	Spacer, .508 ID x .75 OD
30	756-0625	1		Roller, Cable
31	790-00096	1	S	Front Guide Bracket, Auger
32	790-00180	1		Frame
33	790-00206	1	S	Guide Bracket, Auger Cable
34	790-00207	1		Guide Bracket, Drive Cable
35	790-00226	1		Cover, Frame
36	634-04142A	1	/P	Wheel Assembly 15 X 5
36	634-04141	1		Wheel Assembly 16 X 4.8 (the wheel axle is mounted in the frame side's upper hex-hole on models equipped with 16" wheels)
36	634-04151	1	S	Rim Only - Wheel size 15 x 5
36	634-04140	1	S	Rim Only - Wheel size 16 x 4.8
36	734-1859	1	S	Tire Only - Wheel size 15 x 5
36	734-1530	1		Tire Only - Wheel size 16 x 4.8
36	734-0255	1	S	Valve Only
37	731-04873	1		Spacer, 1.25 x .75 x 3.0
38	738-04168	1	S	Axle, .75 x 22"
39	741-0919	1	S	Ball Bearing
40	710-0106	1	/P	Hex Screw, 1/4-20, 1.25, Gr5
41	710-0191	1	/P	Hex Screw, 3/8-24, 1.25, Gr8
42	710-0672	1	/P	Hex Screw, 5/16-24, 1.25,
43	710-0654A	1	/P	Screw, Sems, 3/8-16, 1.00
44	710-1245B	1	/P	Hex Screw, 5/16-24, .875, Gr8

31AE6LLG790 SB-628 (2005-2)
Drive Assembly

Page 6 of 9

Ref #	Part Number	Qty	S/P/F	Description
45	712-04064	1	/P	Nut, Flange Lock, 1/4-20, Nylon
46	726-04012	1	S	Nut, Push-on, .25 Dia.
47	731-05353	1		Cover, Belt
48	732-04308A	1	/P	Spring, Torsion, .850 ID x .354
49	736-0247	1	/P	Washer, Flat, .406 x 1.25 x .157
50	736-0362	1	/P	Washer, Flat, .330 x 1.25 x .06
51	736-0505	1		Washer, Flat, .34 x 1.50 x .150
52	748-04053	1	S	Pulley, Adap, .75 Dia W/dd
53	748-04112	1		Spacer, Shoulder
54	750-04303	1		Spacer, .875 ID x 1.185 OD
55	750-04477	1		Spacer, .340 x .750 x .360
56	754-04050	1	S	Belt, Auger Drive
57	754-04088	1		Belt, Wheel Drive
58	756-04109	1		Pulley, Auger Drive, 8.1 x .5
59	756-04113	1		Pulley, Half, V x 2.600 OD
60	756-04179	1	S	Pulley, Half, 1/4-V x 1.5 OD
61	790-00208	1		Idler Bracket, Wheel Drive
62	790-00230	1		Sleeve, Bearing Idler
63	750-04571	1		Spacer, Shoulder, .26 x .79 X.538
64	735-04054	1	S	Rubber, Friction Wheel, 5.5 OD
65	710-0751	1	/P	Hex Screw, 1/4-20, .620, Gr5
66	732-04311	1		Spring, Torsion, .750 ID x .968
67	738-04184	1		Screw, Shoulder, .37 x .105, 1/4-20
68	790-00156	1		Bracket, Shift Spacer
69	790-00217	1	S	Pivot Bracket, Speed Selector
70	790-00218	1	S	Shift Bracket, Speed Selector
71	712-04063	1	/P	Nut, Flange Lock, 5/16-18, Nylon
72	736-0119	1	S	Washer, Lock, 5/16

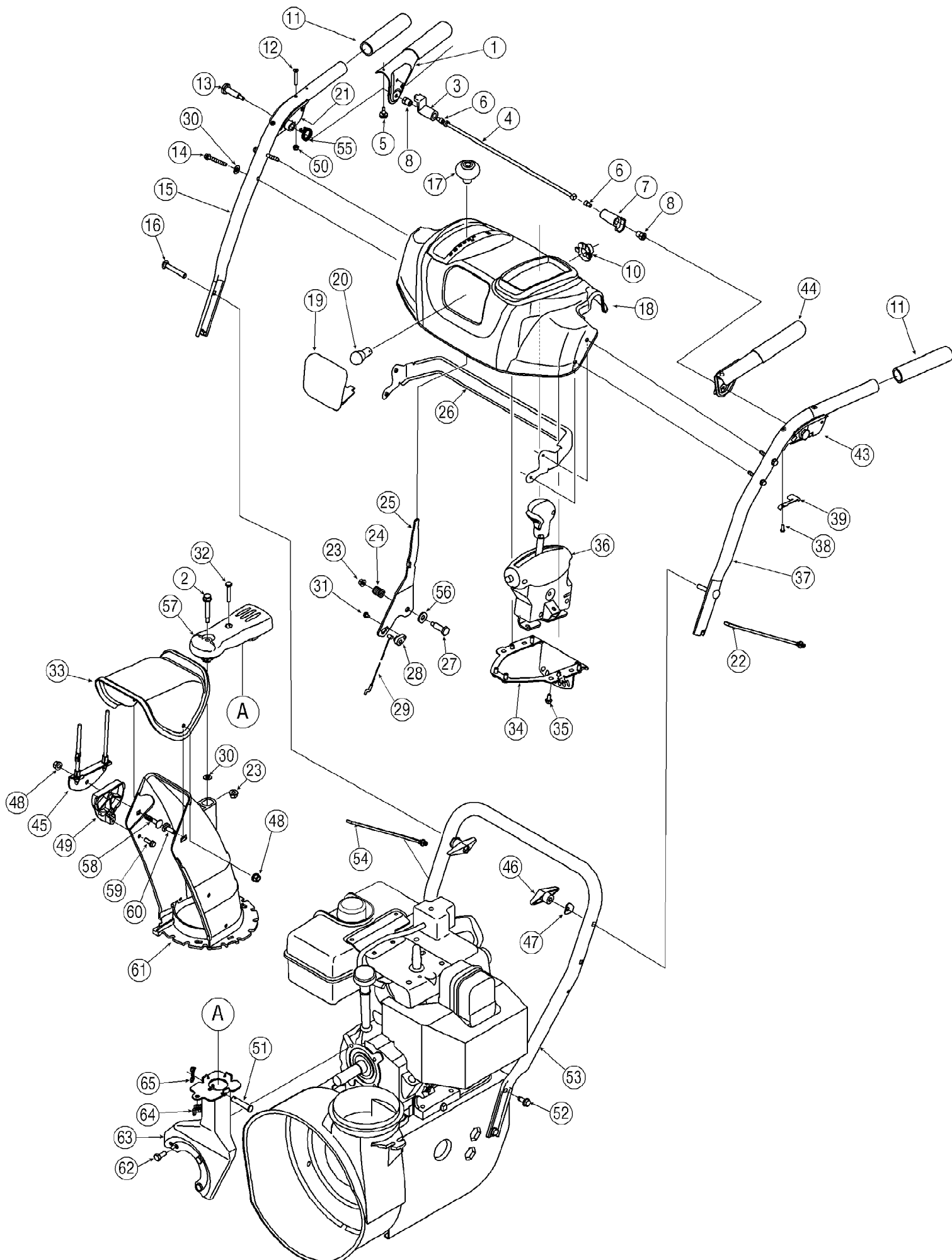

31AE6LLG790 SB-628 (2005-2)
Handle Assembly

Page 8 of 9

Ref #	Part Number	Qty	S/P/F	Description
1	684-04109A	1		Handle Engagement Assembly
2	738-04194	1		Flange Shoulder Screw
3	731-04894A	1	S	Lock Plate
4	711-04287	1	S	Pivot Rod
5	735-0199A	1	S	Rubber Bumper
6	710-04354	1	/P	Screw, 1/4-20 x.375
7	731-04896A	1	S	Clutch Lock Cam
8	712-04081A	1		Shoulder Nut, 1/4-20
9	725-04214	1		Wire Harness (Not Shown)
10	725-1649	1	S	Light Socket
11	720-0274	1	/P	Handle Grip
12	710-1233	1	/P	Screw, #10-24 x 0.375
13	738-04122	1	S	Shoulder Screw, 1/4-20 x 1.345
14	710-1026	1	/P	Screw, 1/4-20 x 1.750
15	749-04141	1		Upper Handle RH
16	710-0449	1	S	Carriage Screw, 5/16-18 x 2.25
17	720-04046	1		Shift Knob
18	731-05347	1	S	Handle Panel, K/L-Style, Black
19	731-05320	1		Lens
20	725-04213	1	S	Lamp
21	731-04784A	1	S	Handle Clutch Lock - RH
22	725-0157	1	/P	Cable Tie
23	712-04064	1	/P	Flange Lock Nut, 1/4-20
24	732-0193	1	/P	Compression Spring
25	790-00203	1	S	Shift Lever
26	790-00140	1	S	Panel Bracket
27	738-04125	1		Shoulder Screw
28	746-0605	1	S	Cable Barrel Holder
29	746-04227	1	S	Speed Selector Cable
30	736-0463	1	S	Flat Washer, .25 x .630 x .0515
31	710-0224	1	S	Screw, #10-16 x .500
32	710-0606	1	/P	Hex Screw, 1/4-20 x 1.50
33	731-04427A	1	/P	Upper Chute
34	790-00131	1	S	Joystick Bracket
35	710-04187	1	/P	Hi-Lo Screw, 1/4-15 x 0.5
36	684-04116A	1	S	4-Way Chute Control™ Assembly (Includes Ref.# 57)
37	749-04142	1		Upper Handle LH
38	710-04326	1		Screw, #8-16 x 0.50
39	732-04219	1	S	Clutch Lock Spring
40	731-04954	1		Steering Control
41	738-04126	1		Pin, 3/16
42	716-04036	1		E Ring
43	731-04785	1	S	Handle Clutch Lock - LH
44	684-04110A	1		Handle Engagement Assembly
45	784-5594	1		Cable Bracket
46	720-0284	1	S	Handle Knob Assembly
47	736-0451	1	S	Saddle Washer
48	712-04063	1	/P	Flange Lock Nut, 5/16-18
49	731-1313C	1	/P	Chute Tilt Cable Guide
50	712-0161	1	/P	Hex Lock Nut, #10-24
51	711-04469A	1		Clevis Pin

31AE6LLG790 SB-628 (2005-2)
Handle Assembly

Page 9 of 9

Ref #	Part Number	Qty	S/P/F	Description
52	710-1260A	1	/P	AB Screw, 5/16-18 x 0.75
53	749-04138	1	S	Lower Handle
54	726-0470	1		Cable Tie
55	732-04238	1		Torsion Spring
56	736-0262	1	/P	Flat Washer
57		1		Joystick Pulley Cover, see reference 36
58	710-0262	1	/P	Carriage Bolt, 5/16-18 x 1.50
59	710-0895	1		Hi-Lo Screw, 1/4-15 x .75
60	710-04071	1		Carriage Bolt, 5/16-18 x 1.0
61	731-04861A	1	/P	Lower Chute
62	710-0627	1	/P	Hex Screw, 5/16-24 x .750
63	684-04162	1		Chute Support Bracket
64	712-3087	1	/P	Wing Nut, 1/4-20
65	714-04040	1		Bow Tie Cotter Pin